

474-2305-91

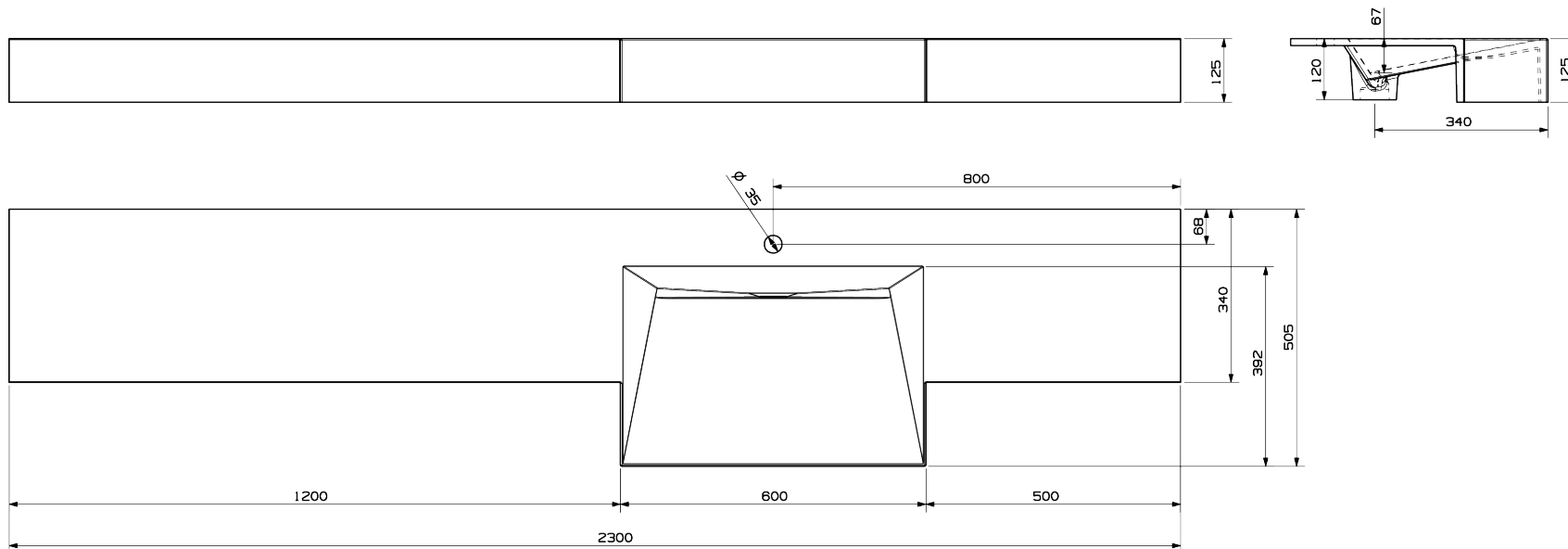

M 1:10

[www.eumardesign.com](http://www.eumardesign.com)

All drawings contain necessary measurements, which are subject to standard tolerances. They are stated in mm and are non-binding. Exact measurements, in particular of customized products, can only be taken from the finished product. Information about tolerances can be found in our General Terms and Conditions (GTC) - [www.eumar.ee/gtc](http://www.eumar.ee/gtc). In the interests of technical progress we reserve the right to introduce technical modifications.