

# downtown 210c\_3 model L1 3054

468-2120-10

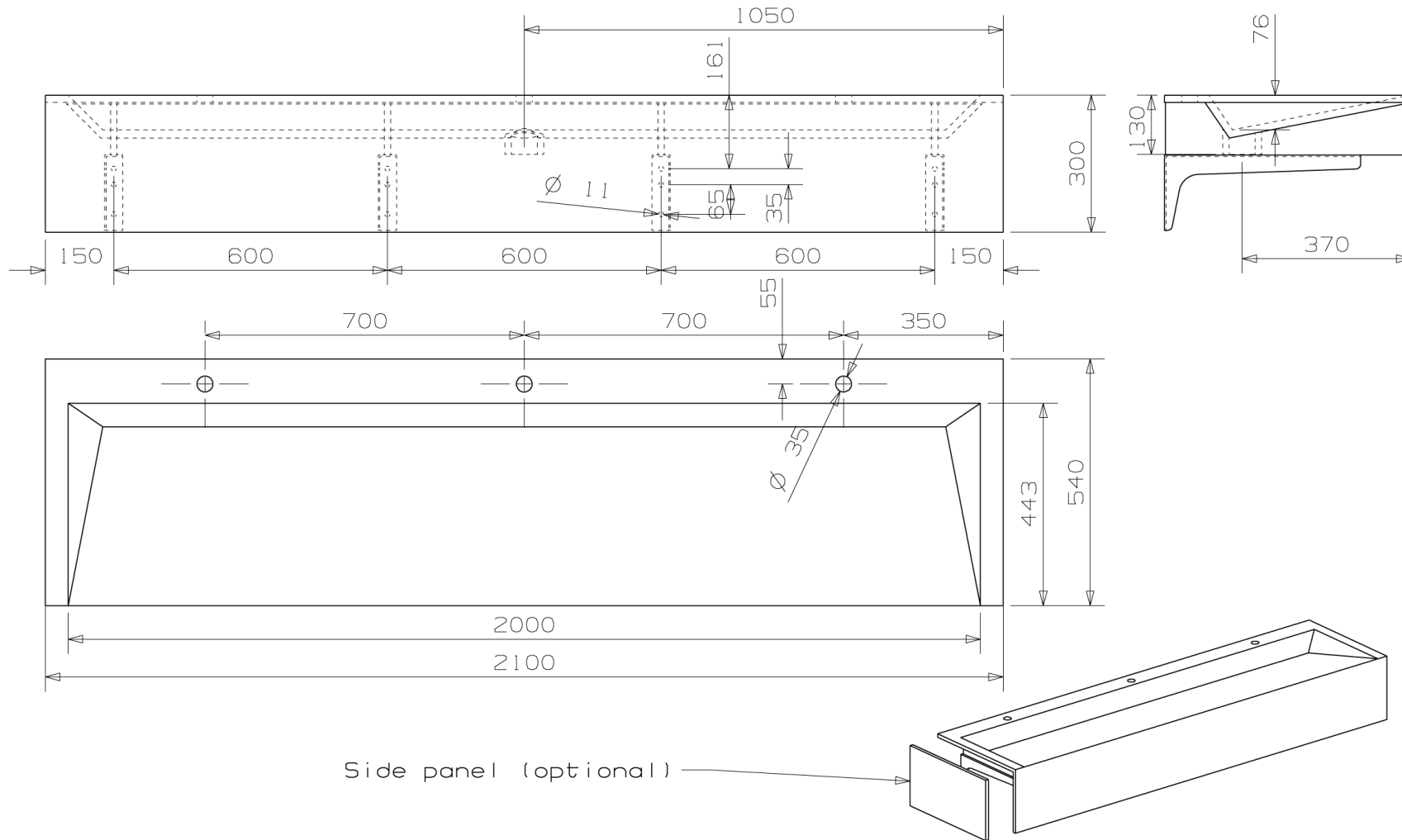

Side panel (optional)

M 1:10

[www.eumardesign.com](http://www.eumardesign.com)