

Downtown 210r_2 model L3 1755

468-2113-79

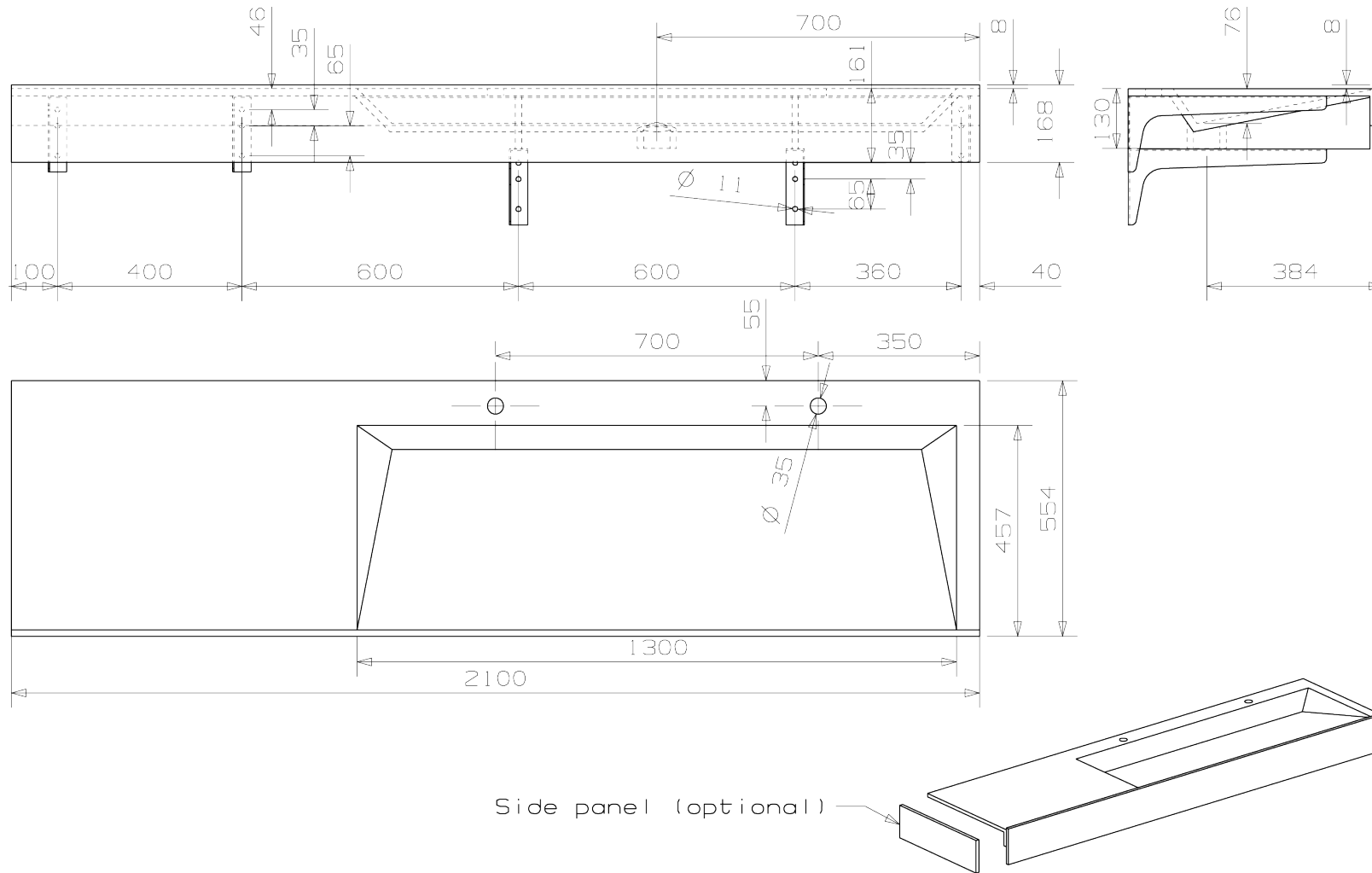

M 1:10

www.eumardesign.com