

# Downtown 350c\_4 model L3 1755

468-3527-19

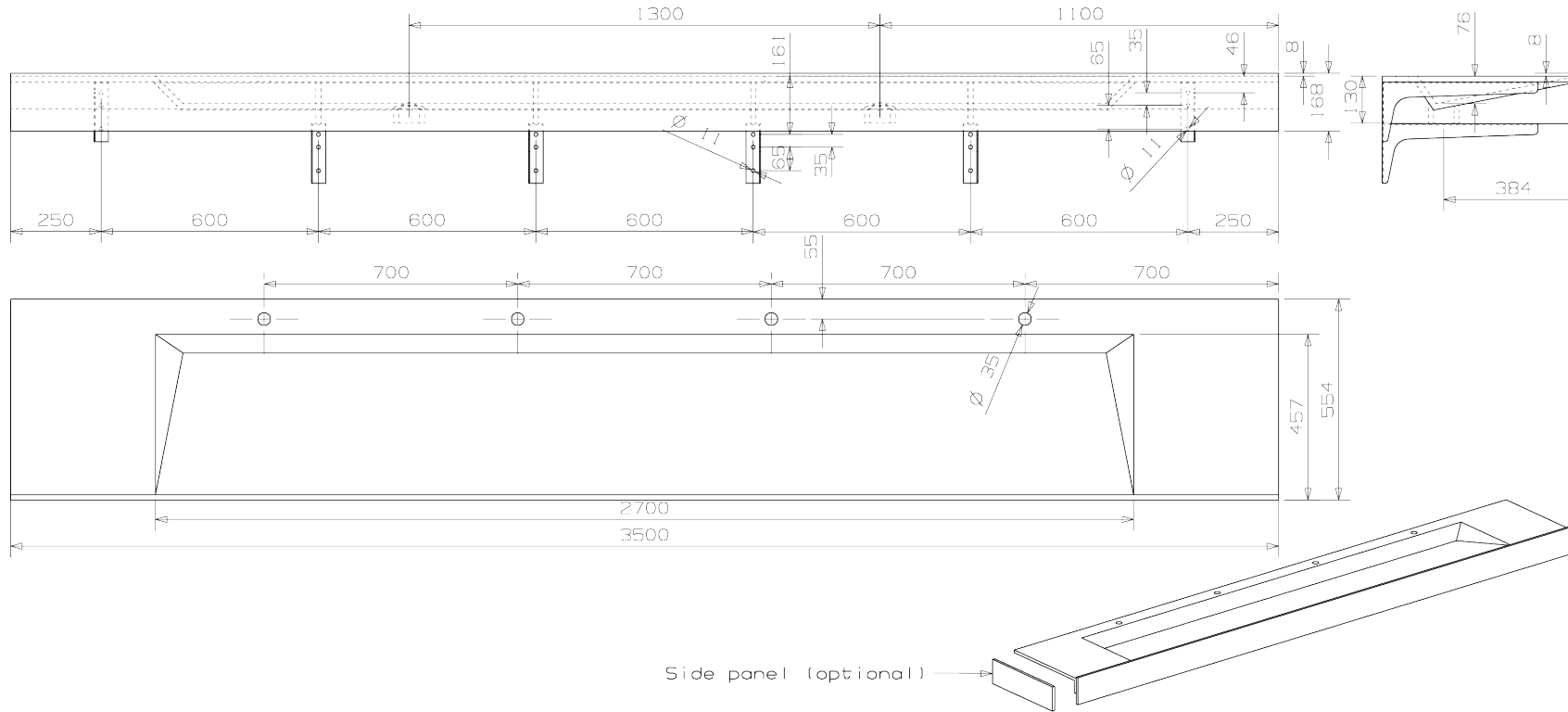

M 1:10

[www.eumardesign.com](http://www.eumardesign.com)