

424-0705-81

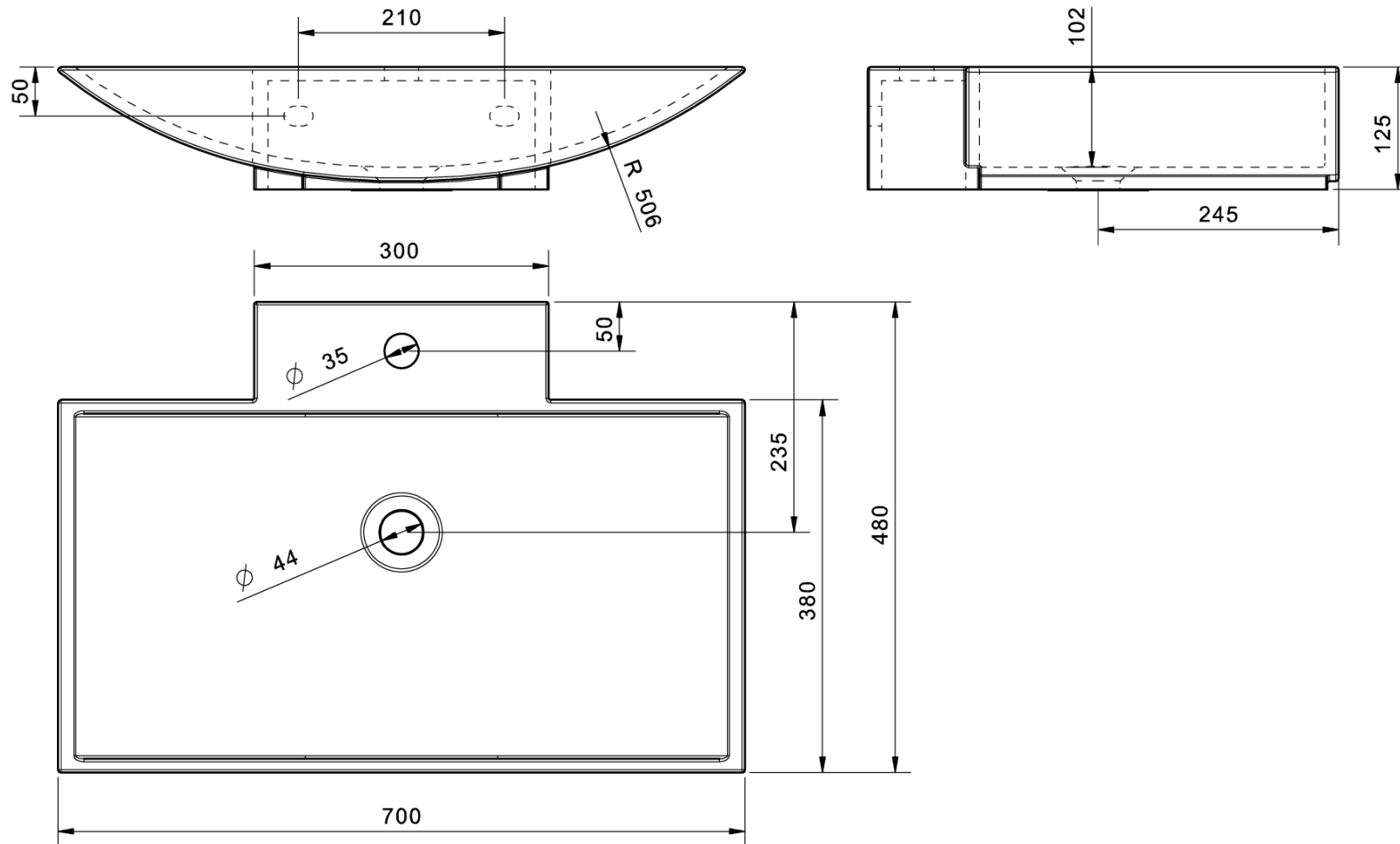

M 1:10

[www.eumardesign.com](http://www.eumardesign.com)